

The hand of a commercial door is determined from outside of the room or building. Please use this guide to specify the hand or swing of a door, door replacement, and door hardware needs.

SINGLE DOORS

1. Left Hand Door (LH) hinges on left, door swings in

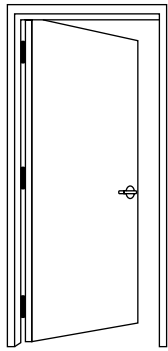

AERIAL VIEW

Inside

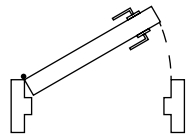

Outside / Keyside

2. Left Hand Reverse (LHR) hinges on left, door swings out

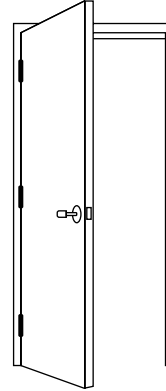

AERIAL VIEW

Inside

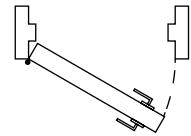

Outside / Keyside

3. Right Hand Door (RH) hinges on right, door swings in

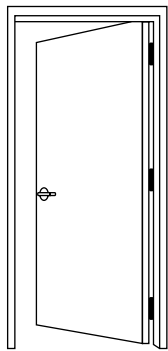

AERIAL VIEW

Inside

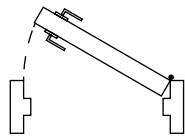

Outside / Keyside

4. Right Hand Reverse (RHR) hinges on right, door swings out

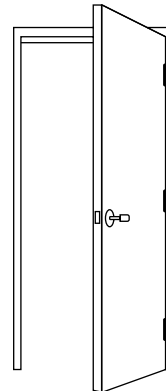

AERIAL VIEW

Inside

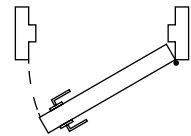

Outside / Keyside

DOUBLE DOORS

1. Left Hand Active (LHA) hinges on left, doors swing in

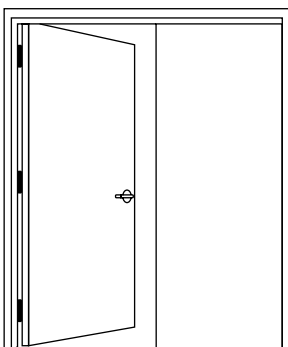

AERIAL VIEW

Inside

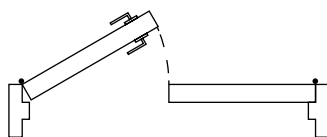

Outside / Keyside

2. Left Hand Reverse Active (LHRA) hinges on left, doors swing out

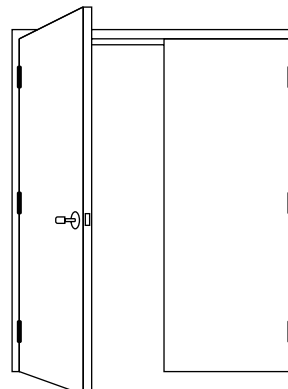

AERIAL VIEW

Inside

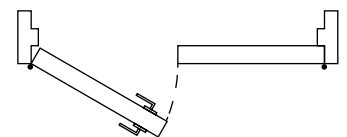

Outside / Keyside

DOUBLE DOORS (continued)

3. Right Hand Active (RHA) hinges on right, doors swing in

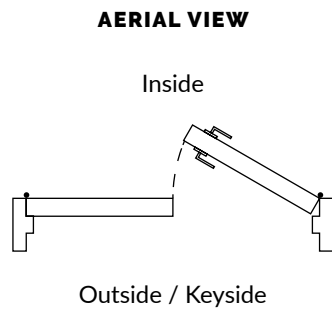
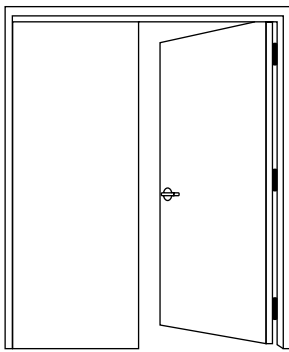

4. Right Hand Reverse Active (RHRA) hinges on right, doors swing out

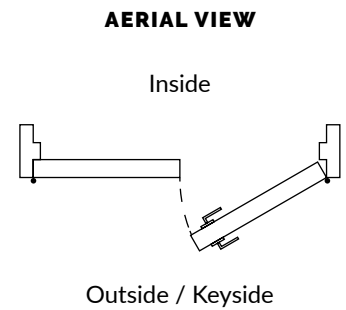
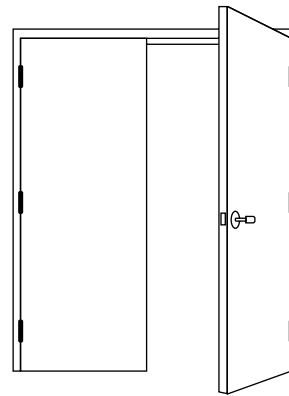

Top and bottom flush bolts are installed inside of inactive doors to secure them when not in use.

DOUBLE DOORS — BOTH ACTIVE

1. Push-Pull

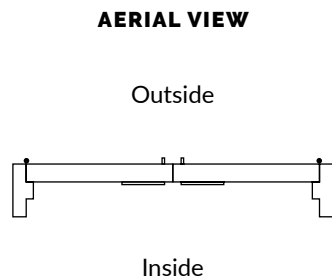
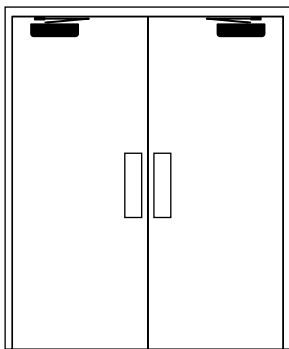

2. Vertical Rod Exit Devices

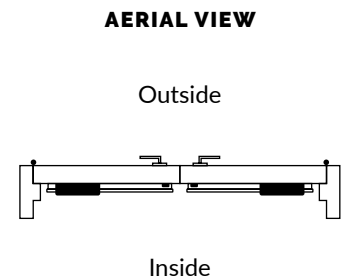
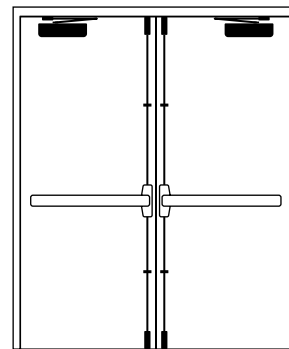

3. Rim Exit Devices with Mullion

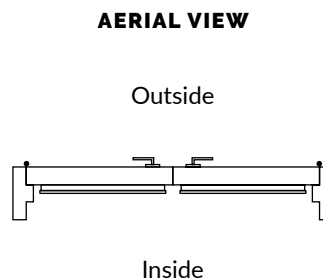
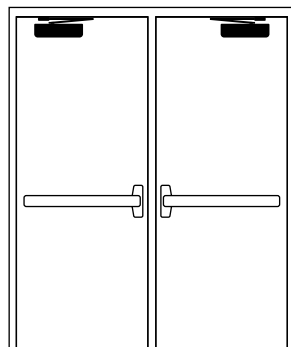

Have a question about proper door handing? We're here to help!

IPS Door Division

5416 Keystone Dr. Fort Wayne, IN 46825 | PH: 260-557-7228 | IPSDoorsDivison.com

ips INTERIOR
PRODUCTS
SUPPLY
A GMS COMPANY